



CLASSIC

10712



 [LEGO.com/classic](https://www.lego.com/classic)



WARNING:
CHOKING HAZARD.
Small parts. Not for
children under 3 years.





AVERTISSEMENT : RISQUE D'ÉTOUFFEMENT.

Contient des petites pièces. Ne convient pas aux enfants de moins de 3 ans.



ADVERTENCIA: PELIGRO DE ASFIXIA.

No recomendado para niños menores de 3 años. Contiene piezas pequeñas.

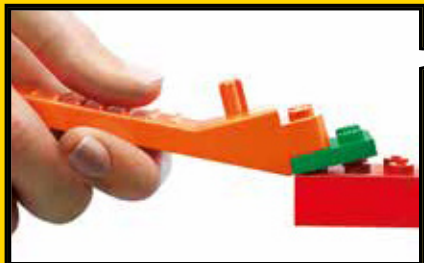
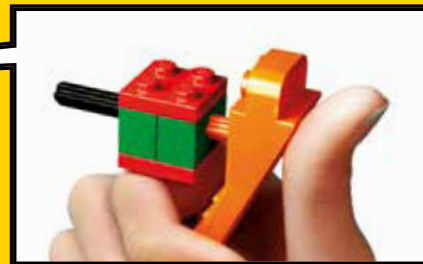
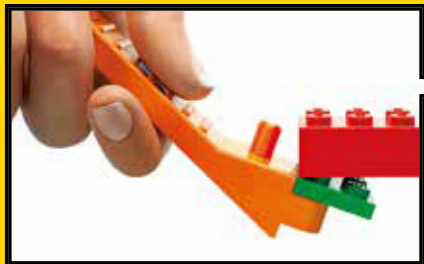



Easy Building
Construction facile
Construcción fácil



Medium Building
Construction intermédiaire
Construcción intermedia



Advanced Building
Construction avancée
Construcción avanzada



p./pag.

6

p./pag.

18



p./pag.
26



p./pag.
48



p./pag.
40





1





2x

2

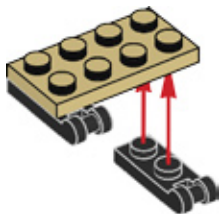

1x

3

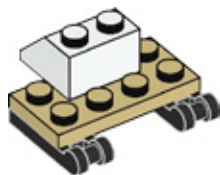

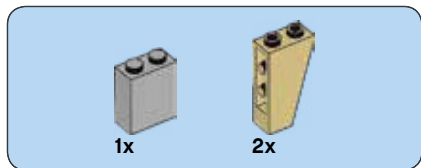

4

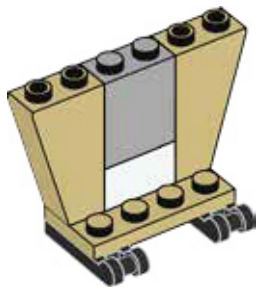

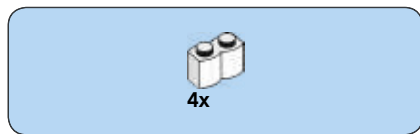

5

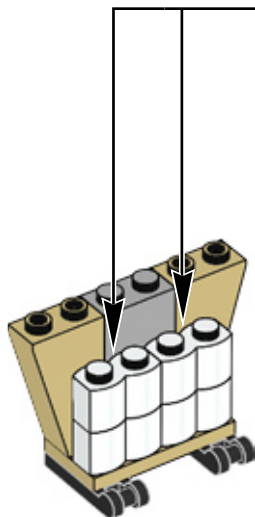
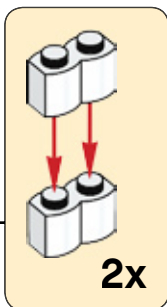

6

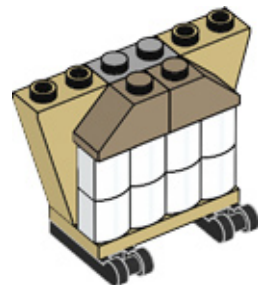



1x



2x

7

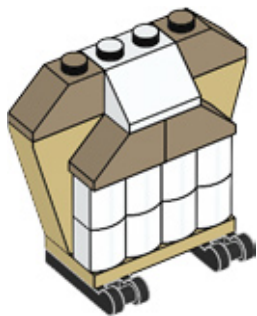



2x



1x

8

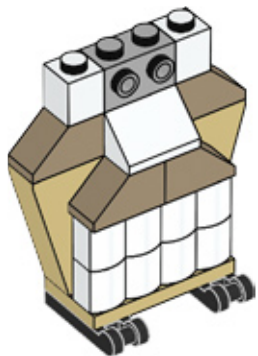

1x



1x

9

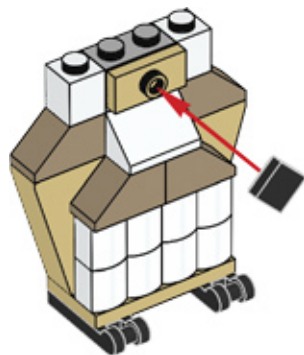



1x

10

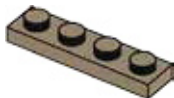



2x

11

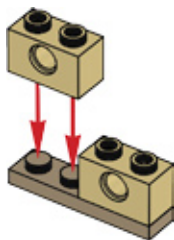

1x

12

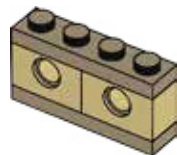



1x



1x

13

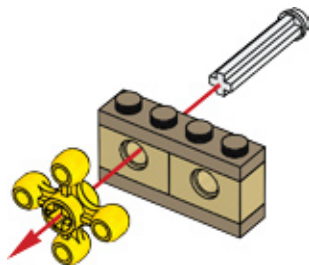

14



1x



1x

14

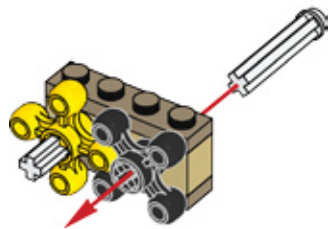

1x

15

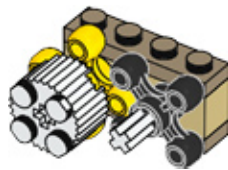

16

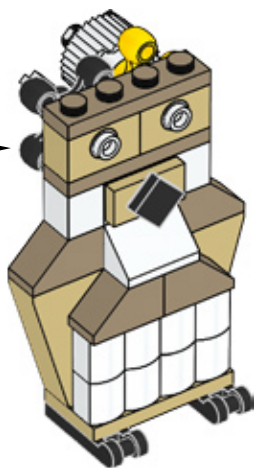



2x



2x

17

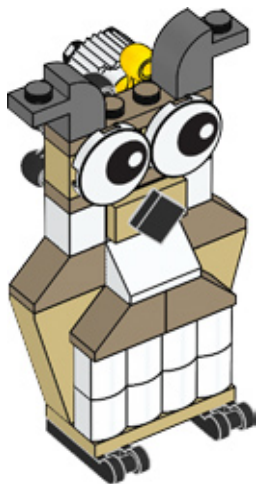

LEGO.com/classic

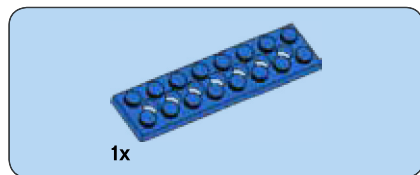

1

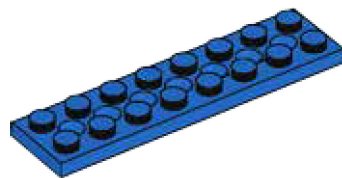



3x

2

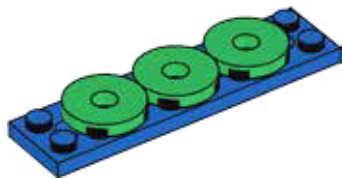

2x

3

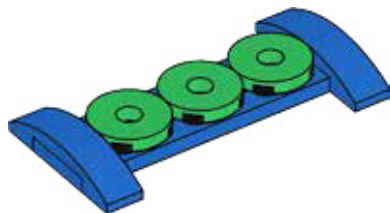

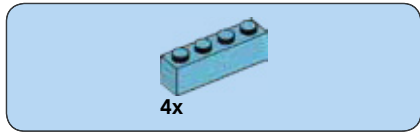

4

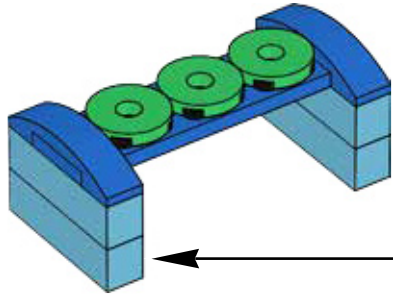
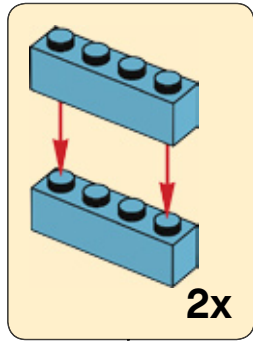

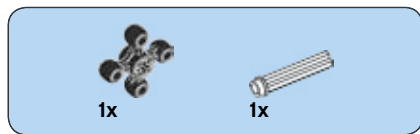

5

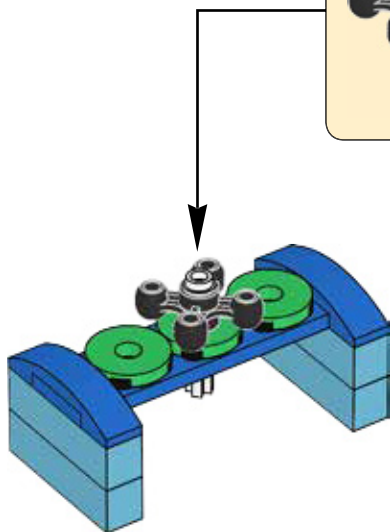
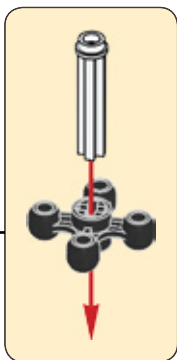

6

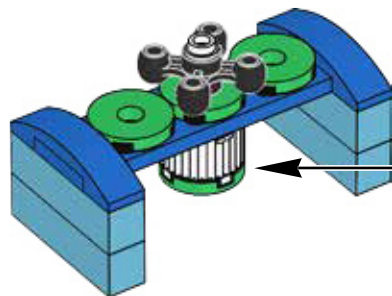
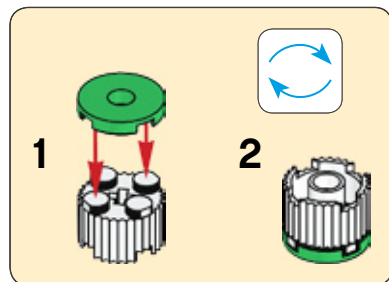



7

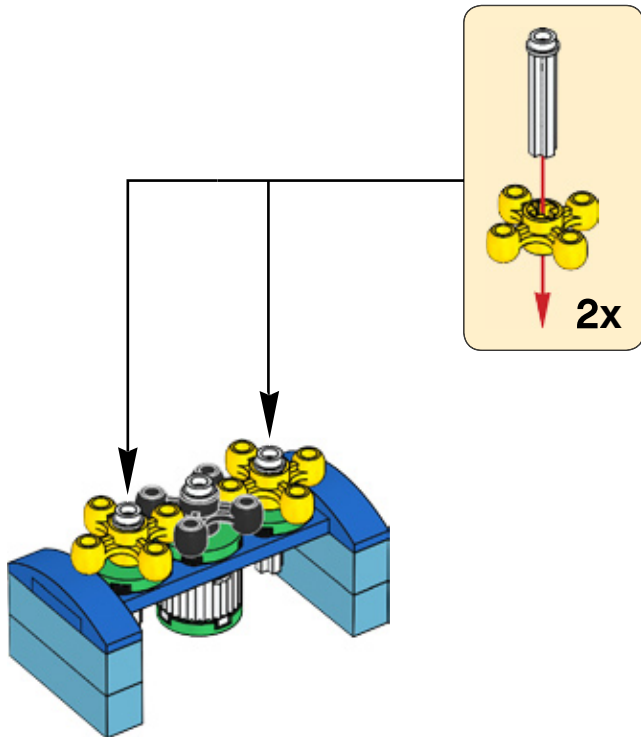



3x

8

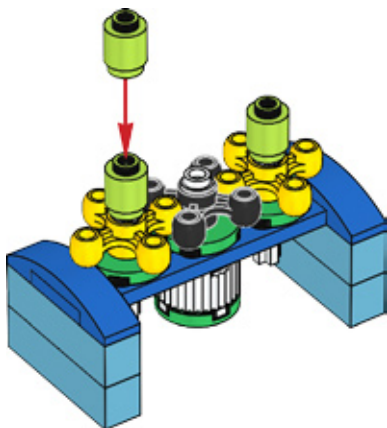

1x



2x

9

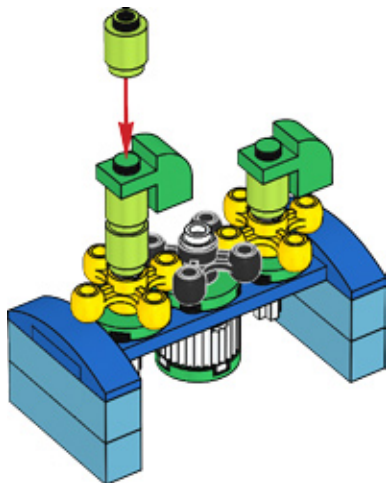



2x

10

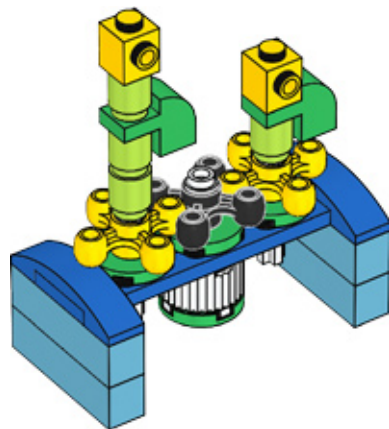

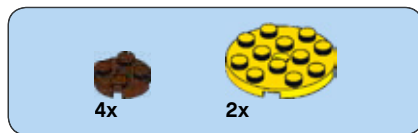

11

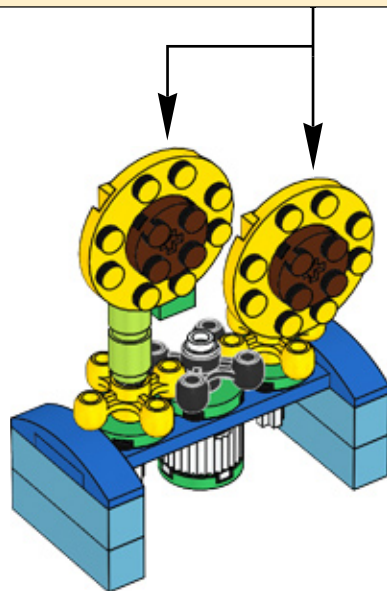
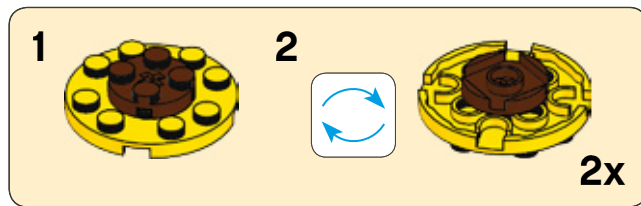

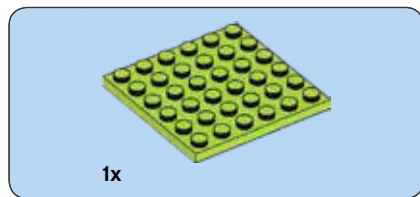

1

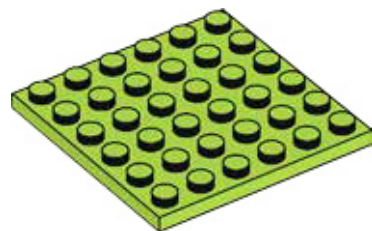



1x

2

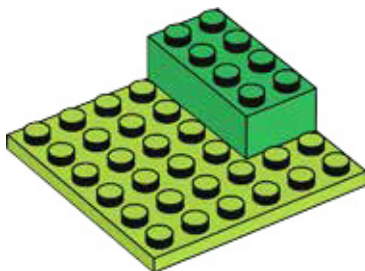



2x

3

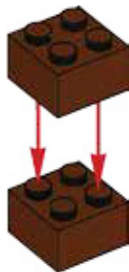

2x

4

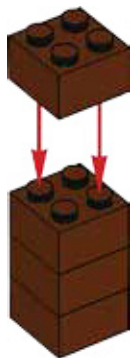



5



6

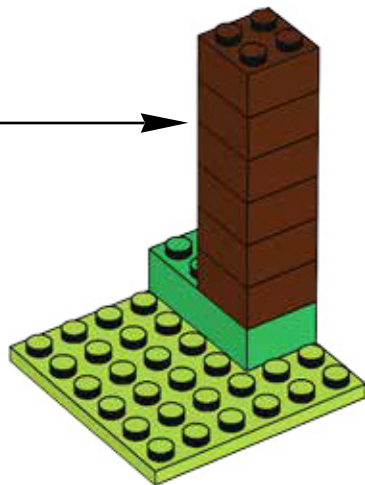

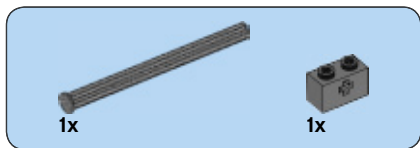
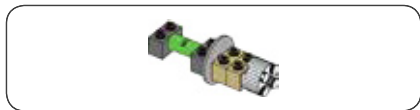

7

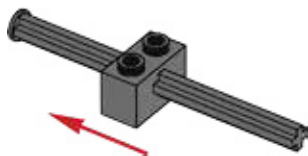



1x



1x

8

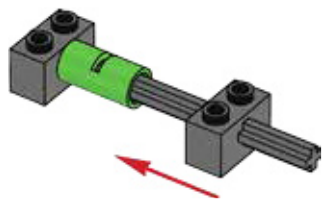

1x

9

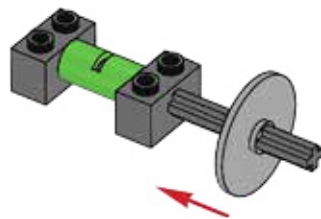



2x

10

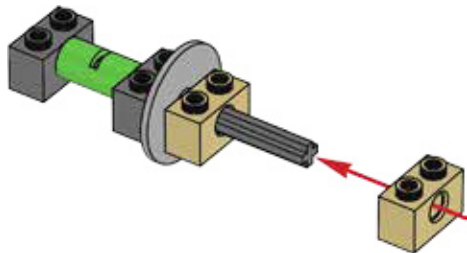



1x

11

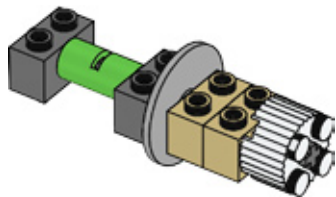

12

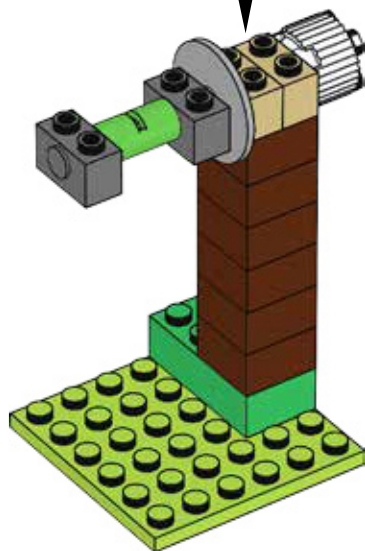



1x



1x

14



1x



1x

15

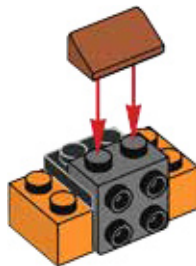



2x



1x

16

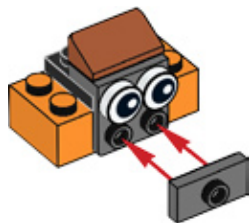

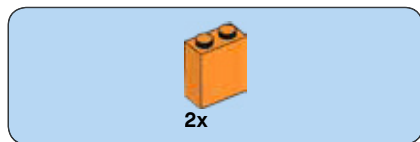

17

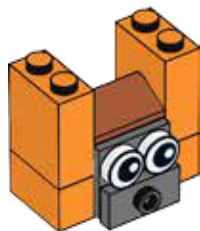

18

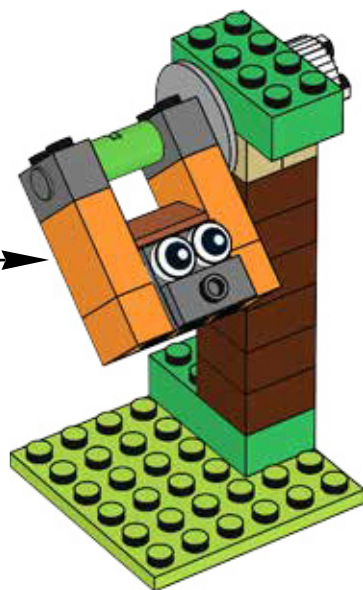



1x



1x

19

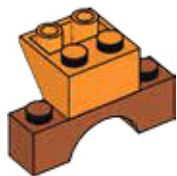

2x

20

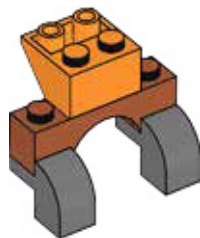

21

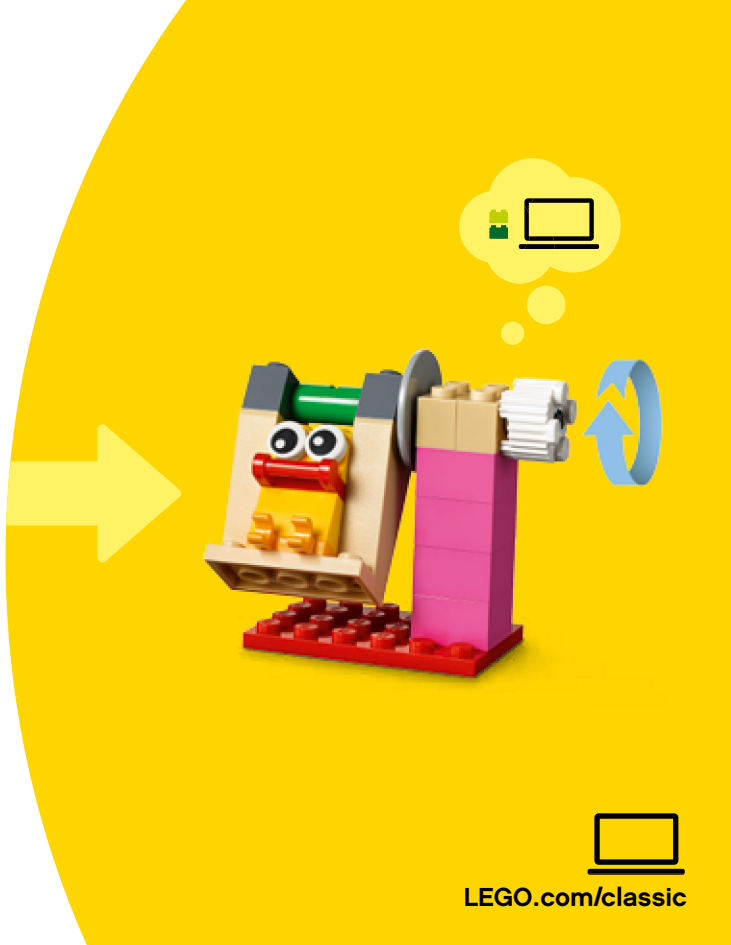
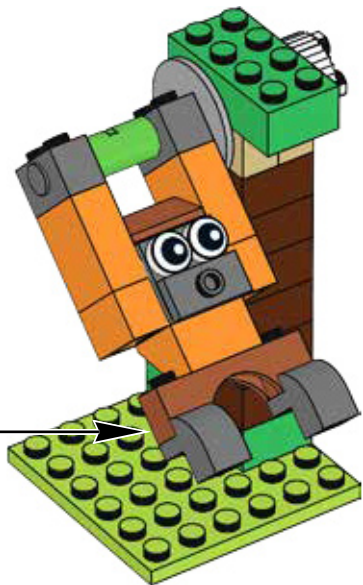

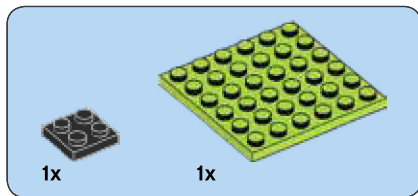

1

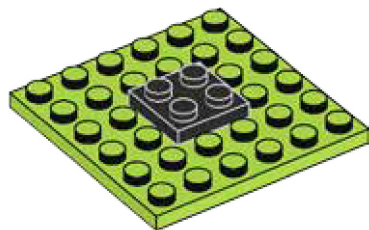



1x

2

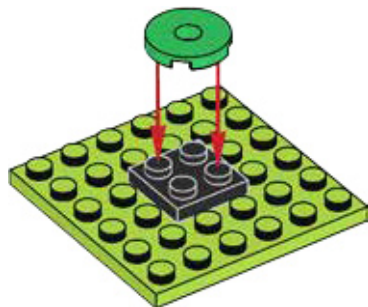

2x



2x

3

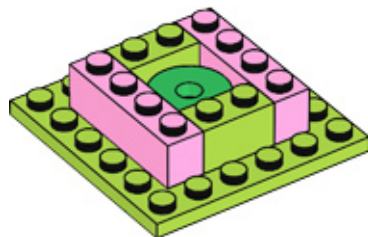



2x

4

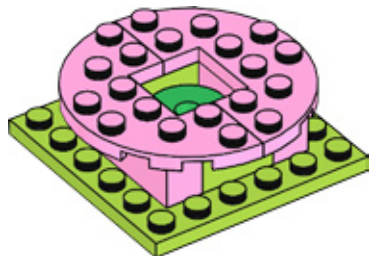

1x

5

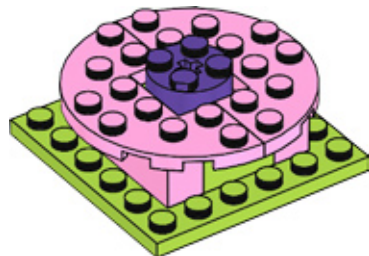

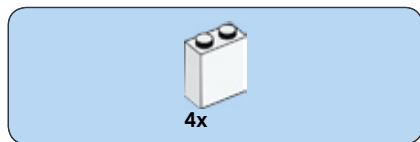

6

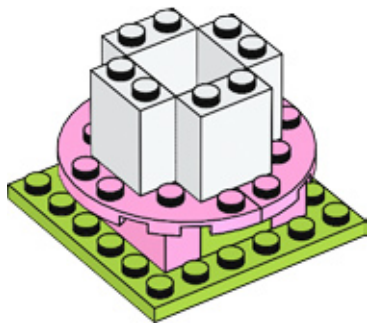

7

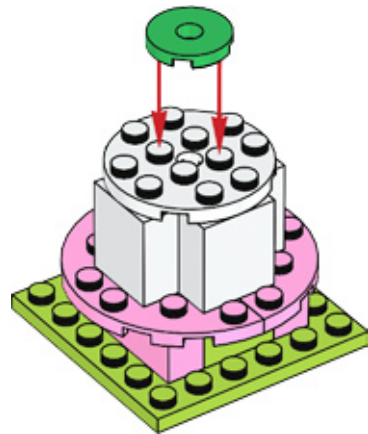

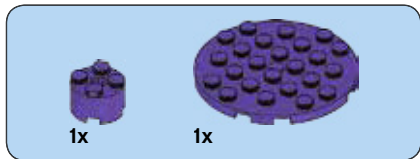

8

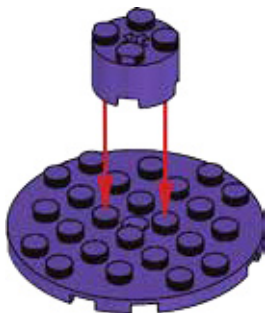

9

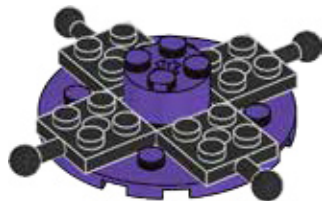



4x



4x

10



4x



4x

11

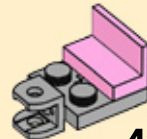

4x

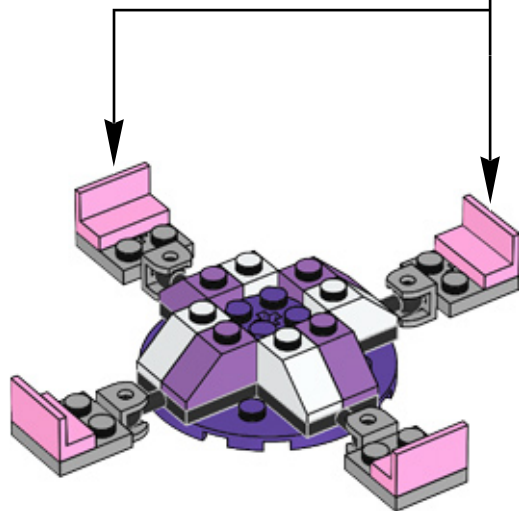

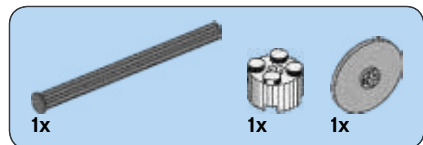

12

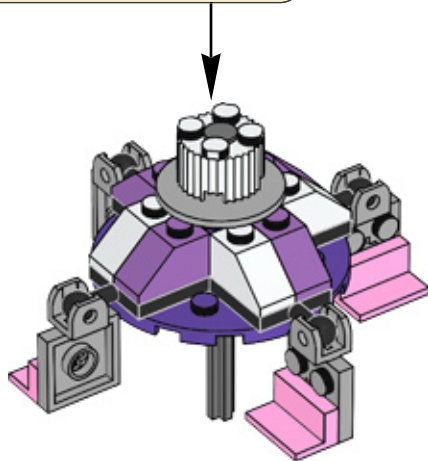
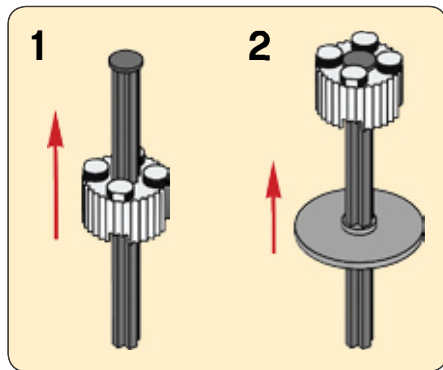

13

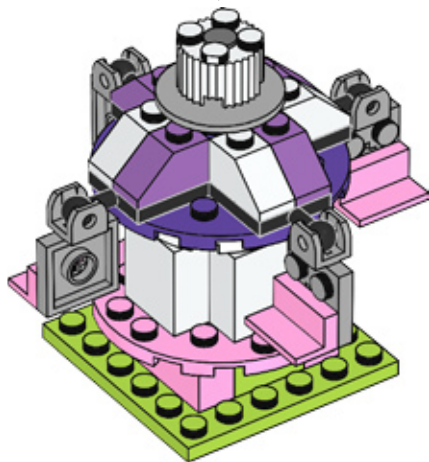

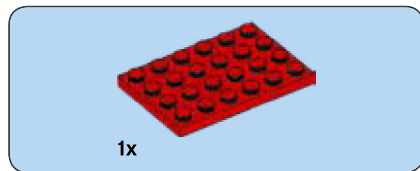

1

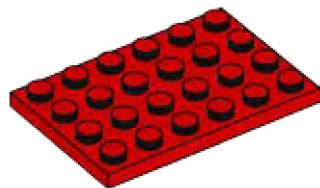

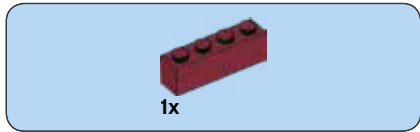

2

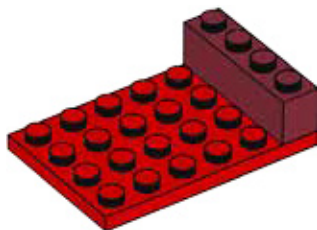

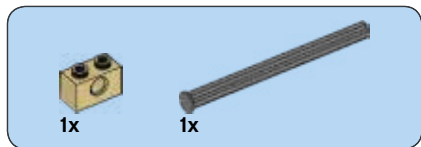
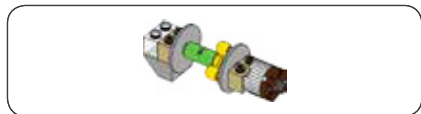

3

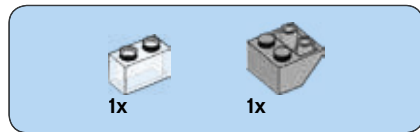
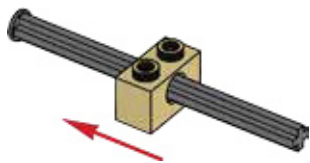

4

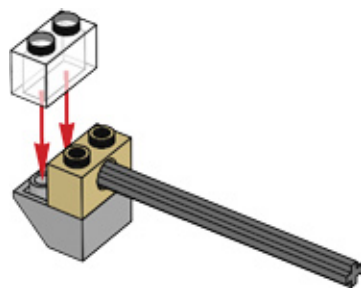

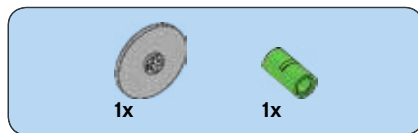

5

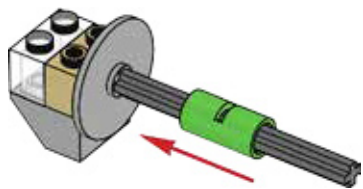

6

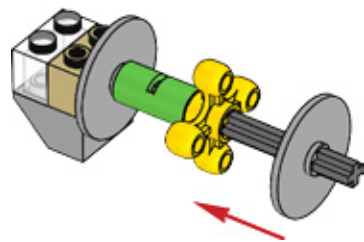



1x



1x

7

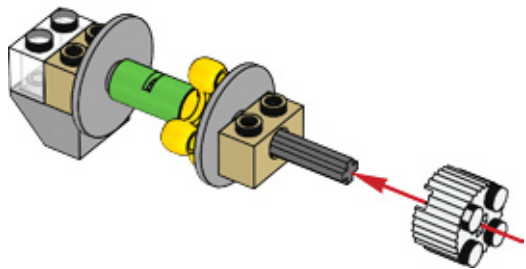

1x

8

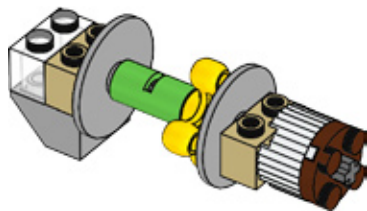

9

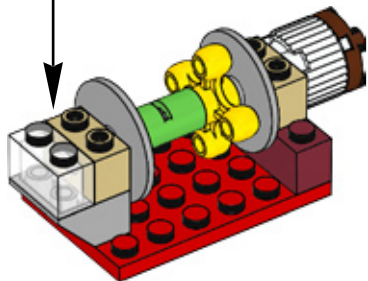

2x



1x

10

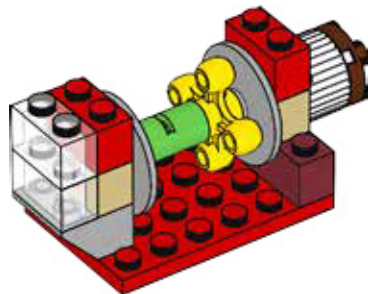

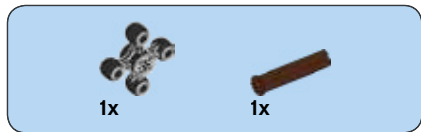

11

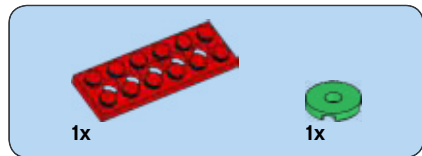

12

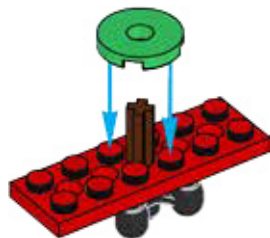



1x

13

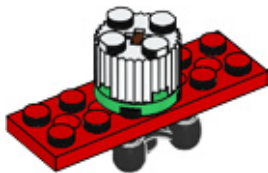

14

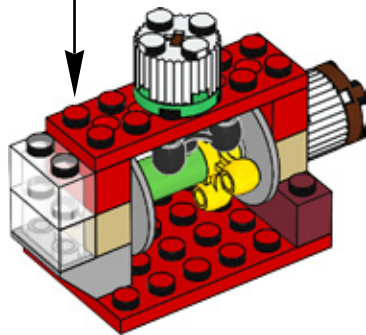

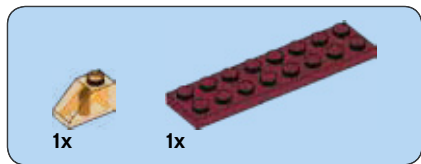

15

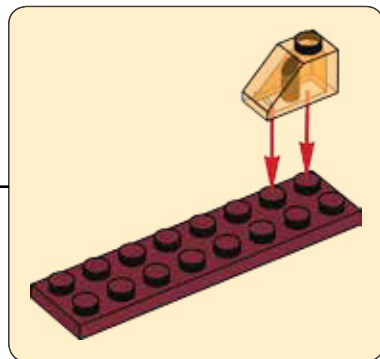
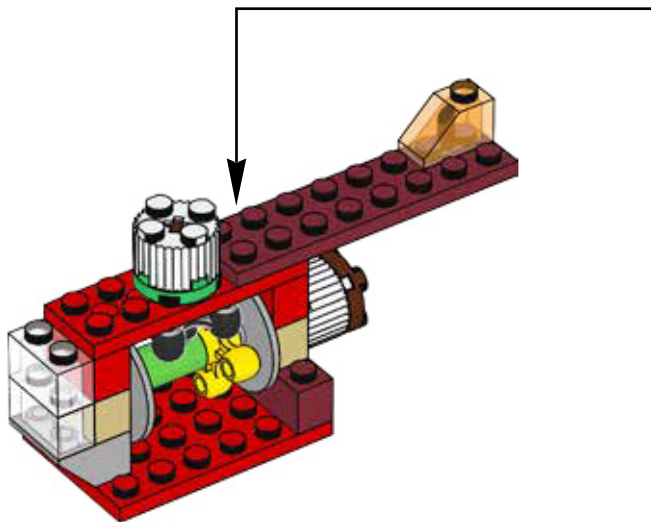



2x

16

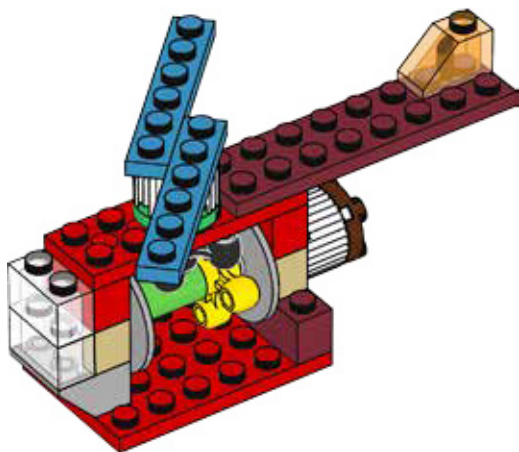

2x

17

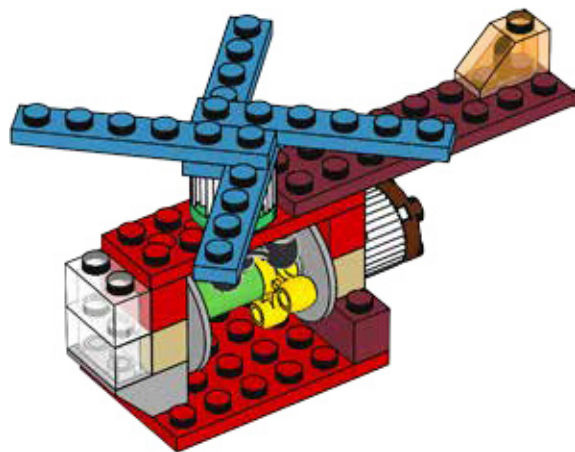



1x

18

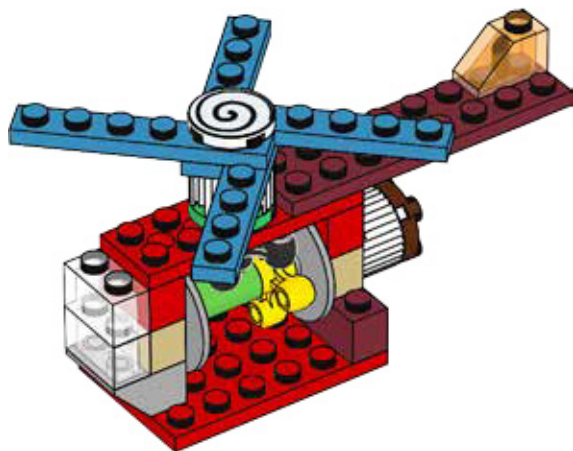

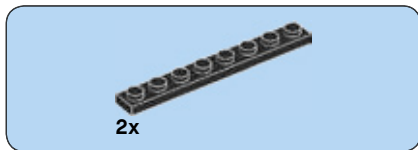
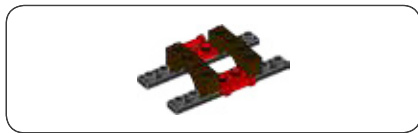

19

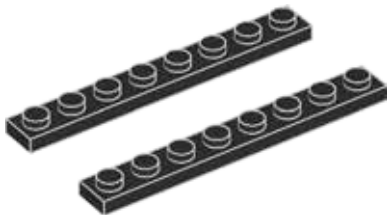

20

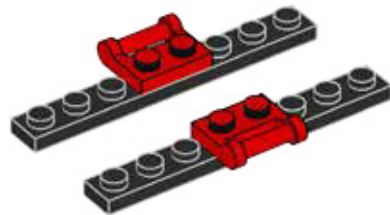



2x

21

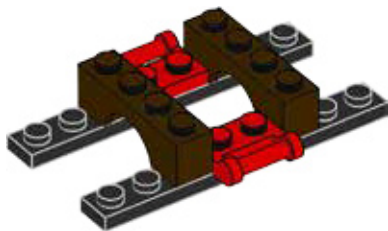

22

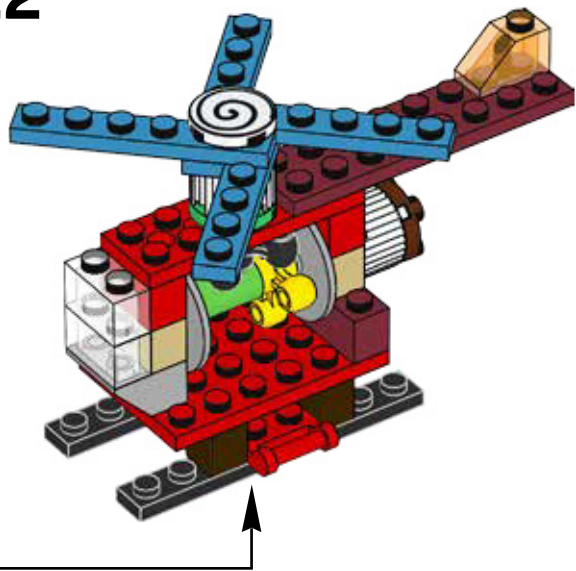

What will you build for Mr. Stareyes' adventures?
Que vas-tu construire pour les aventures de M. Rêvétoilé ?
¿Qué construirás para las aventuras del Sr. Ojos de Estrella?





10698



10696



10713



10700



10714



10701



CITY



60170



60171



60172



60173



60174



60176



CREATOR



31075

2x
6029156

4x
6194809

2x
300501

2x
4224792

2x
6215018

2x
6060734

6x
4650644

4x
6059185

4x
4113261

4x
4121932

1x
6047220

2x
303901

5x
6217157

1x
4515347

2x
4160387

1x
4527947

7x
4205107

2x
6092587

2x
6030731

2x
4114309

4x
300323

2x
4649773

1x
373823

4x
300421

2x
4226876

2x
300121

1x
4582843

1x
303221

3x
6173135

2x
4624985

4x
4203493

2x
366024

2x
428624

2x
4515349

7x
6074954

2x
6100223

2x
4106356

2x
614126

2x
307026

4x
4578677

3x
4248204

2x
302226

2x
4515368

4x
6051038

2x
292626

2x
346026

2x
306540

2x
6078590

2x
4118829

2x
4118827

2x
4153827

1x
4654448

4x
4530678

2x
4626904

2x
6052777

1x
6152321

4x
4212454

2x
4164022

2x
4234716

2x
4525858

2x
6188477

2x
6212897

2x
6022650

2x
6093459

4x
6132408

1x
6057616

2x
6015344

2x
4211564

2x
4211614

4x
4667578

4x
4530469

1x
4211436

2x
6178919

4x
4210797

4x
6013658

2x
6092572

1x
6117972

3x
4499858

4x
4517992

5x
4211159

6x
4211210

2x
6135494

4x
6146231

2x
4518890

2x
6133060

2x
6036232

1x
6102580

2x
4622176

1x
6216908

2x
4623775

2x
6004943

4x
6151657

4x
6036238

4x
6022005

3

8

Customer Service
Kundenservice
Service Consommateurs
Servicio Al Consumidor

LEGO.com/service or dial

 : 00800 5346 5555
: 1-800-422-5346

WIN

GO TO WWW.LEGO.COM/PRODUCTFEEDBACK AND
GIVE US YOUR SHORT **FEEDBACK** ABOUT THIS
LEGO® SET FOR A CHANCE TO WIN
A COOL LEGO PRIZE.

Terms & Conditions apply

LEGO.com/productfeedback



GEWINNE

Erzähle uns auf
www.LEGO.com/productfeedback

etwas über die Erfahrungen, die du mit
diesem LEGO® Set gemacht hast, und
sichere dir die Chance auf einen coolen
LEGO Preis!

Es gelten die Teilnahmebedingungen

GAGNE

Rends-toi sur
www.LEGO.com/productfeedback

et donne-nous quelques commentaires sur
ce produit LEGO® pour avoir une chance
de gagner un prix LEGO !

Voir Conditions Générales

GANAN

Visita
www.LEGO.com/productfeedback

y envíanos tu opinión acerca de este set
LEGO®. ¡Participarás en el sorteo de un
premio LEGO!

Términos y Condiciones aplicables

获取奖品

登录
www.LEGO.com/productfeedback

给出关于此乐高®套装的简短反馈，
就有机会获得炫酷乐高奖品

《条款及条件》适用

LEGO and the LEGO logo are trademarks of the/son des marques de commerce du/son marcas registradas de LEGO Group. ©2018 The LEGO Group.

6225660